

Multi **Mono** Specialised

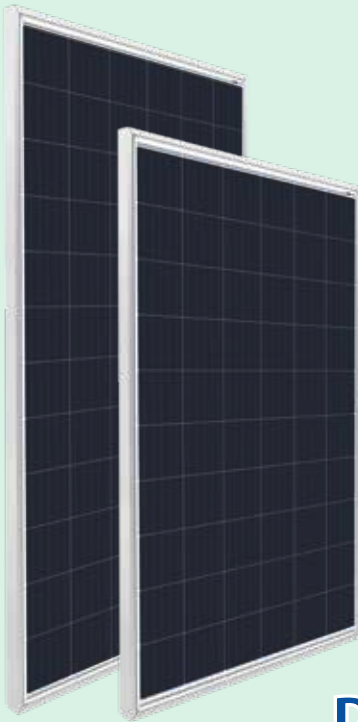

*Module images for representation purpose only

Solar PV Module DESERV 3S6 or 3S6H Mono PERC

Series G1





60 Cells: 315 Wp - 330 Wp

72 Cells: 380 Wp - 400 Wp

The ideal PV Module for all applications that use the highest quality of PV Cells, in-house Encapsulants, and Backsheets.





SAFE

-  IP67 Junction box
-  10 YEARS 10 years of product warranty
-  25 YEARS 25 Years of limited power output warranty
-  1000 Vdc or 1500 Vdc







RELIABLE

-  Extreme weather resilience
-  Windspeed - 2400 Pa, Snowload - 5400 Pa
-  Highly reliable anti-reflective coated glass



HIGH PERFORMANCE

-  PID resistant
-  Superlative performance in low light
-  High power density
-  Positive power tolerance

Ideal for:



Residential



Commercial



Utility



Off-grid

Certifications:

- IEC 61215 : 2016 (3S6H) (305-320 Wp, 375-400 Wp)
- IEC 61730 : 2016 (3S6H) (305-320 Wp, 375-400 Wp)
- IEC TS 62804
- IEC 61701, 62716
- IEC 61853 - 1 (3S6H 380-400 Wp)
- IEC 61853 - 2 (3S6H 385 Wp)
- IEC 60068-2-68
- BIS Number R-63000760
- Independently audited by SOLARBUYER
- IMS Certified Company - ISO 9001: 2015 & OHSAS 45001: 2018
- EMS - ISO 14001: 2015



RenewSys is the first integrated manufacturer of Solar PV Modules and its key components- Encapsulants (EVA and POE), Backsheets and Solar PV Cells. We have a global presence with offices in India, Mauritius, Nigeria, South Africa, Singapore, UAE, China, representatives in Brazil, Europe, USA, Mexico, and an evolving distributor network.

Corporate Office

Unit No. 607, 6th Floor, Trade Center, Bandra-Kurla Complex, Bandra East, Mumbai - 400 051, Maharashtra, India

Factory

Plot No.6, Survey # 114/P, Srinagar Village, Maheshwaram Mandal, Dist - Rangareddy, Hyderabad - 501 359, Telangana, India

- Please refer to the installation manual for detailed information.

Performance under standard test conditions (1000w/m², AM 1.5, 25 °C)

DESERV 3S6 or 3S6H (Wp)	60 Cells				72 Cells				
	315	320	325	330	380	385	390	395	400
Rated power (P _{max}), Wp	315	320	325	330	380	385	390	395	400
Max. power voltage (V _{mp}), V	33.65	33.80	33.95	34.02	40.39	40.57	40.74	40.83	41.08
Max. power current (I _{mp}), A	09.39	09.49	09.58	09.71	09.42	09.50	09.57	09.69	09.75
Open circuit voltage (V _{oc}), V	41.40	41.48	41.55	41.58	49.69	49.78	49.87	49.90	49.93
Short circuit current (I _{sc}), A	09.93	09.99	10.05	10.14	09.93	09.99	10.05	10.11	10.18
Module efficiency (%)	18.94	19.24	19.54	19.84	19.14	19.39	19.64	19.89	20.15
NOCT (Wp) at 45 ± 2 °C @800 W/m²									
P _{max} (W)	234.43	238.15	241.87	245.59	282.80	286.52	290.25	293.97	297.69
Max. power voltage (V _{mp}), V	30.77	30.91	31.04	31.11	36.93	37.10	37.25	37.34	37.57
Max. power current (I _{mp}), A	07.64	07.72	07.79	07.88	07.67	07.73	07.79	07.88	07.93
Open circuit voltage (V _{oc}), V	38.49	38.56	38.63	38.66	46.20	46.28	46.37	46.39	46.42
Short circuit current (I _{sc}), A	08.11	08.16	08.21	08.25	08.11	08.16	08.21	08.25	08.31

Mechanical Characteristics	60 & 72
Cable	No. 12 AWG, 4mm ² , (1.2m Standard)
PV Connectors	MC4 Connectors / MC4 Compatible
Frame	Anodized Aluminum Alloy
Junction box	IP67 Junction box with 4 rail (3 bypass diodes of 15 A)
Glass	3.2mm Thick low iron tempered (4mm available on request)

Operating Conditions	60 & 72
Ambient temperature, °C	-40 to +85
Max. system voltage, Vdc	1000 or 1500
Hail impact velocity, m/sec	23
Max. surface load capacity, Pa	5400
Max. wind speed capacity, Pa	2400

Cell Temperature Coefficient	Mono PERC
Open circuit voltage	-0.36 % / °C
Short circuit current	+0.07 % / °C
Nominal power	-0.38 % / °C

Physical Parameters	315 Wp - 330 Wp	380 Wp - 400 Wp
	No. of cells	60
Module dimension (mm)	1663 X 1000 (± 2)	1985 X 1000 (± 2)
Module thickness (mm)	35	35
Approximate weight (kg)	18.2	21.8
Packaging Configuration	60	72
No. of Modules/pallet	29	29

Module Dimension Diagrams (mm)

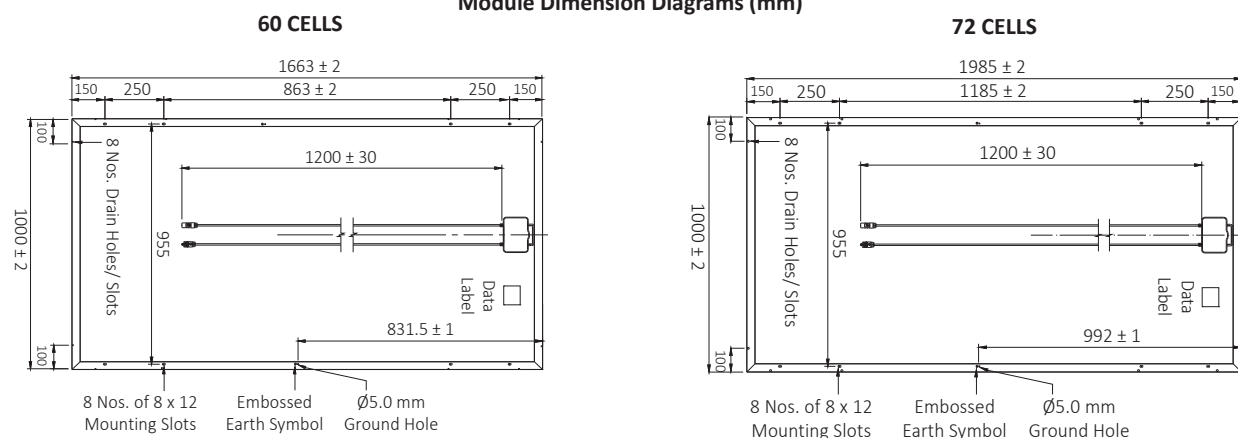

*Due to continuous product updation, specifications may change without notice. Kindly refer to the website for latest information: www.renewsysworld.com